



FK Frame

Breaking capacities

Icu 400/415V AC in kA eff.

Type	V	N	H	L
FK800	50	50	80	100
FK1250	50	50	80	100
FK1600	50	50	80	

Protection

Trip Unit	Rated Current (A)	LTM	Mag Break™	SMR1e ⁽¹⁾	SMR1s ⁽¹⁾	SMR1g ⁽¹⁾
FK800	630	N, H, L				
	800	N, H, L	N, H, L	N, H, L	N, H	N, H
FK1250	1000	N, H, L		N, H, L	N, H	N, H
	1250	N, H, L	N, H, L	N, H, L	N, H	N, H
FK1600	1600			N, H	N, H	N, H

LTM

Line thermal magnetic protection

SMR1e

Selective electronic protection.

SMR1s

Selective electronic protection with enhanced functionality

SMR1g

Selective electronic protection with enhanced functionality and ground fault

Mag Break™

Magnetic only breaker for motor protection

Y

Non Automatic or switch (not mentioned in tables)

Number of poles / protected poles (trips)

3 pole 3 trips	N, H, L	N, H, L	N, H, L	N, H	N, H
4 pole 3 trips	N, H, L	N, H, L	N, H, L	N, H	N, H
4 pole 4 trips ⁽¹⁾			N, H, L	N, H	N, H

(1) Switchable, 0%, 50% or 100% neutral protection

Accessories (main types)

- ① A maximum of one Bell Alarm contact AND 3 aux. contacts (all of CO type)
- ② Shunt or Undervoltage release
- ③ Operators
Rotary handle
OR
Electrical operator
- ④ Draw out system
- ⑤ Connectors for auxiliary wiring
- ⑥ RCD with separate sensor

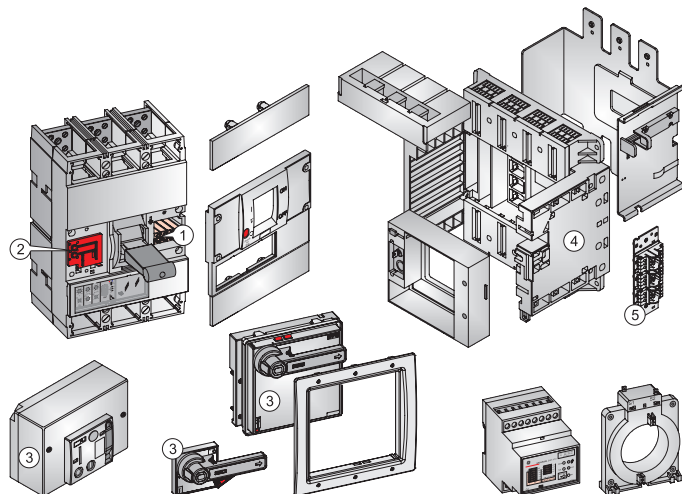

FK800 - Complete Circuit Breaker

Selective Electronic Trip Unit type SMR1e



50kA FKV	In (A)	3 pole 3 trips		4 pole ⁽¹⁾ N selectable 0-50-100%	
		Cat. nr.	Ref. nr.	Cat. nr.	Ref. nr.
	800	FKV36NE800PPF	435041	FKV46NE800PPF	435042
50kA FKN	800	FKN36NE800PPF	435393	FKN46NE800PPF	435447
80kA FKH	800	FKH36NE800PPF	435285	FKH46NE800PPF	435339
100kA FKL	800	FKL36NE800PPF	435390	FKL46NE800PPF	435282
One code covers: A standard fixed front connection breaker + Assembled trip unit + Toggle Elongator + Breaker finishing covers + Fixation hardware					

Enhanced Selective Electronic Trip Unit type SMR1s

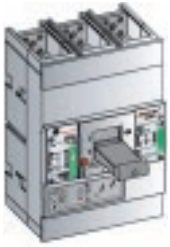

50kA FKN	In (A)	3 pole 3 trips		4 pole ⁽¹⁾ N selectable 0-50-100%	
		Cat. nr.	Ref. nr.	Cat. nr.	Ref. nr.
	800	FKN36NS800PPF	435429	FKN46NS800PPF	435483
80kA FKH	800	FKH36NS800PPF	435321	FKH46NS800PPF	435375
One code covers: A standard fixed front connection breaker + Assembled trip unit + Toggle Elongator + Breaker finishing covers + Fixation hardware					

Enhanced Selective Electronic Trip Unit type SMR1g (= s + ground fault)

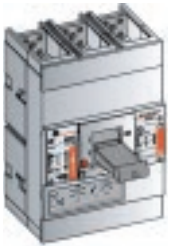

50kA FKN	In (A)	3 pole 3 trips		4 pole ⁽¹⁾ N selectable 0-50-100%	
		Cat. nr.	Ref. nr.	Cat. nr.	Ref. nr.
	800	FKN36NG800PPF	435411	FKN46NG800PPF	435465
80kA FKH	800	FKH36NG800PPF	435303	FKH46NG800PPF	435357
One code covers: A standard fixed front connection breaker + Assembled trip unit + Toggle Elongator + Breaker finishing covers + Fixation hardware					

Line Thermal magnetic trip unit LTM (adjustable settings)



50kA FKV	In (A)	3 pole 3 trips		4 pole 3 trips ⁽²⁾	
		Cat. nr.	Ref. nr.	Cat. nr.	Ref. nr.
	800	FKV36NT800PF	435005	FKV46NT800PF	435064
50kA FKN	630	FKN36NT630PF	435444	FKN436NT630PF	435408
	800	FKN36NT800PF	435336	FKN436NT800PF	435300
80kA FKH	630	FKH36NT630PF	435426	FKH436NT630PF	435462
	800	FKH36NT800PF	435318	FKH436NT800PF	435354
100kA FKL	630	FKL36NT630PF	435480	FKL436NT630PF	435534
	800	FKL36NT800PF	435372	FKL436NT800PF	435535
One code covers: A standard fixed front connection breaker + Assembled trip unit + Toggle Elongator + Breaker finishing covers + Fixation hardware					

Motor Protection (Mag Break™) Magnetic Only Breaker

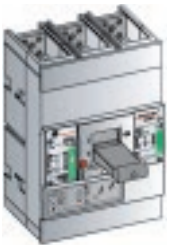

50kA FKN	In (A)	3 pole 3 trips		4 pole 3 trips ⁽²⁾	
		Cat. nr.	Ref. nr.	Cat. nr.	Ref. nr.
	800	FKN36NM800PF	435537	FKN436NM800PF	435541
80kA FKH	800	FKH36NM800PF	435538	FKH436NM800PF	435542
100kA FKL	800	FKL36NM800PF	435539	FKL436NM800PF	435543
One code covers: A standard fixed front connection breaker + Assembled trip unit + Toggle Elongator + Breaker finishing covers + Fixation hardware					

(1) Switchable 0%, 50% or 100% neutral protection, neutral on left.

(2) Neutral on left

FK1250 - Complete Circuit Breaker

Selective Electronic Trip Unit type SMR1e



	In (A)	3 pole 3 trips		4 pole ⁽¹⁾ N selectable 0-50-100%	
		Cat. nr.	Ref. nr.	Cat. nr.	Ref. nr.
50kA FKV	1000	FKV36NE100SQF	435040	FKV46NE100SQF	435066
	1250	FKV36NE125SSF	435035	FKV46NE125SSF	435083
50kA FKN	1000	FKN36NE100SQF	435396	FKN46NE100SQF	435450
	1250	FKN36NE125SSF	435384	FKN46NE125SSF	435438
80kA FKH	1000	FKH36NE100SQF	435288	FKH46NE100SQF	435342
	1250	FKH36NE125SSF	435276	FKH46NE125SSF	435330
100kA FKL	1000	FKL36NE100SQF	435545	FKL46NE100SQF	435547
	1250	FKL36NE125SSF	435546	FKL46NE125SSF	435549
One code covers: A standard fixed front connection breaker + Assembled trip unit + Toggle Elongator + Breaker finishing covers + Fixation hardware					

Enhanced Selective Electronic Trip Unit type SMR1s

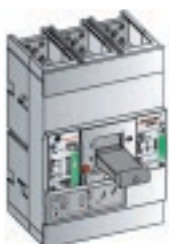

	In (A)	3 pole 3 trips		4 pole ⁽¹⁾ N selectable 0-50-100%	
		Cat. nr.	Ref. nr.	Cat. nr.	Ref. nr.
50kA FKN	1000	FKN36NS100SQF	435432	FKN46NS100SQF	435486
	1250	FKN36NS125SSF	435420	FKN46NS125SSF	435474
80kA FKH	1000	FKH36NS100SQF	435324	FKH46NS100SQF	435378
	1250	FKH36NS125SSF	435312	FKH46NS125SSF	435366
One code covers: A standard fixed front connection breaker + Assembled trip unit + Toggle Elongator + Breaker finishing covers + Fixation hardware					

A

Enhanced Selective Electronic Trip Unit type SMR1g (= s + ground fault)

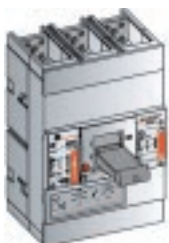

	In (A)	3 pole 3 trips		4 pole ⁽¹⁾ N selectable 0-50-100%	
		Cat. nr.	Ref. nr.	Cat. nr.	Ref. nr.
50kA FKN	1000	FKN36NG100SQF	435414	FKN46NG100SQF	435468
	1250	FKN36NG125SSF	435402	FKN46NG125SSF	435456
80kA FKH	1000	FKH36NG100SQF	435306	FKH46NG100SQF	435360
	1250	FKH36NG125SSF	435294	FKH46NG125SSF	435348
One code covers: A standard fixed front connection breaker + Assembled trip unit + Toggle Elongator + Breaker finishing covers + Fixation hardware					

Line Thermal magnetic trip unit LTM (adjustable settings)



	In (A)	3 pole 3 trips		4 pole 3 trips ⁽²⁾	
		Cat. nr.	Ref. nr.	Cat. nr.	Ref. nr.
50kA FKV	1000	FKV36NT100SF	435028	FKV46NT100SF	435086
	1250	FKV36NT125SF	435030	FKV46NT125SF	435089
50kA FKN	1000	FKN36NT100SF	435550	FKN436NT100SF	435562
	1250	FKN36NT125SF	435551	FKN436NT125SF	435563
80kA FKH	1000	FKH36NT100SF	435553	FKH436NT100SF	435565
	1250	FKH36NT125SF	435554	FKH436NT125SF	435566
100kA FKL	1000	FKL36NT100SF	435555	FKL436NT100SF	435567
	1250	FKL36NT125SF	435557	FKL436NT125SF	435569
One code covers: A standard fixed front connection breaker + Assembled trip unit + Toggle Elongator + Breaker finishing covers + Fixation hardware					

Motor Protection (Mag Break™) Magnetic Only Breaker

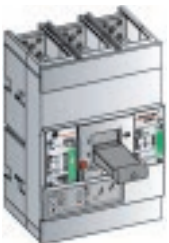

	In (A)	3 pole 3 trips		4 pole 3 trips ⁽²⁾	
		Cat. nr.	Ref. nr.	Cat. nr.	Ref. nr.
50kA FKN	1250	FKN36NM125SF	435558	FKN436NM125SF	435570
80kA FKH	1250	FKH36NM125SF	435559	FKH436NM125SF	435571
100kA FKL	1250	FKL36NM125SF	435561	FKL436NM125SF	435573
One code covers: A standard fixed front connection breaker + Assembled dummy trip unit + Toggle elongator + Breaker finishing covers + Fixation hardware					

(1) Switchable 0%, 50% or 100% neutral protection, neutral on left. (2) Neutral on left

FK1600 - Complete Circuit Breaker

Selective Electronic Trip Unit type SMR1e



	In (A)	3 pole 3 trips		4 pole ⁽¹⁾ N selectable 0-50-100%	
		Cat. nr.	Ref. nr.	Cat. nr.	Ref. nr.
50kA FKV	1600	FKV36NE160TTF	435032	FKV46NE160TTF	4435092
	One code covers: A standard fixed front connection breaker - Assembled trip unit - fixation hardware (Electrical Operator not possible)				
50kA FKN	1600	FKN36NE160TTF	435387	FKN46NE160TTF	435441
80kA FKH	1600	FKH36NE160TTF	435279	FKH46NE160TTF	435333
One code covers: A standard fixed front connection breaker + Assembled trip unit + Toggle Elongator + Breaker finishing covers + Fixation hardware					

Enhanced Selective Electronic Trip Unit type SMR1s

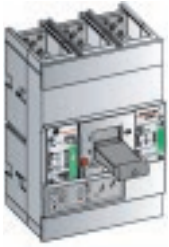

	In (A)	3 pole 3 trips		4 pole ⁽¹⁾ N selectable 0-50-100%	
		Cat. nr.	Ref. nr.	Cat. nr.	Ref. nr.
50kA FKN	1600	FKN36NS160TTF	435423	FKN46NS160TTF	435477
80kA FKH	1600	FKH36NS160TTF	435315	FKH46NS160TTF	435369
One code covers: A standard fixed front connection breaker + Assembled trip unit + Toggle Elongator + Breaker finishing covers + Fixation hardware					

Enhanced Selective Electronic Trip Unit type SMR1g (= s + ground fault)



	In (A)	3 pole 3 trips		4 pole ⁽¹⁾ N selectable 0-50-100%	
		Cat. nr.	Ref. nr.	Cat. nr.	Ref. nr.
50kA FKN	1600	FKN36NG160TTF	435405	FKN46NG160TTF	435459
80kA FKH	1600	FKH36NG160TTF	435297	FKH46NG160TTF	435351
One code covers: A standard fixed front connection breaker + Assembled trip unit + Toggle Elongator + Breaker finishing covers + Fixation hardware					

FKY- Non-Automatic Circuit Breaker (Switch)

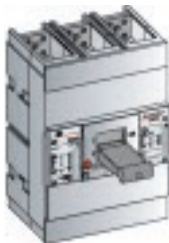

	In (A)	3 pole		4 pole ⁽²⁾	
		Cat. nr.	Ref. nr.	Cat. nr.	Ref. nr.
FKY	800	FKY306DN800PF	435495	FKY406DN800PF	435504
	1000	FKY306DN100SF	435381	FKY406DN100SF	435273
	1250	FKY306DN125SF	435489	FKY406DN125SF	435498
	1600	FKY306DN160TF	435492	FKY406DN160TF	435501
One code covers: A standard fixed front connection breaker + Assembled dummy trip unit + Toggle elongator + Breaker finishing covers + Fixation hardware					

(1) Switchable 0%, 50% or 100% neutral protection, neutral on left.

(2) Neutral on left